

ONKYO®

Compact Disc Player
C-7000R

Instruction Manual

COMPACT
disc
DIGITAL AUDIO



WARNING:

TO REDUCE THE RISK OF FIRE OR ELECTRIC SHOCK, DO NOT EXPOSE THIS APPARATUS TO RAIN OR MOISTURE.

CAUTION:

TO REDUCE THE RISK OF ELECTRIC SHOCK, DO NOT REMOVE COVER (OR BACK). NO USER-SERVICEABLE PARTS INSIDE. REFER SERVICING TO QUALIFIED SERVICE PERSONNEL.



WARNING
RISK OF ELECTRIC SHOCK
DO NOT OPEN

AVIS
RISQUE DE CHOC ELECTRIQUE
NE PAS OUVRIR



The lightning flash with arrowhead symbol, within an equilateral triangle, is intended to alert the user to the presence of uninsulated "dangerous voltage" within the product's enclosure that may be of sufficient magnitude to constitute a risk of electric shock to persons.



The exclamation point within an equilateral triangle is intended to alert the user to the presence of important operating and maintenance (servicing) instructions in the literature accompanying the appliance.

Important Safety Instructions

1. Read these instructions.
2. Keep these instructions.
3. Heed all warnings.
4. Follow all instructions.
5. Do not use this apparatus near water.
6. Clean only with dry cloth.
7. Do not block any ventilation openings. Install in accordance with the manufacturer's instructions.
8. Do not install near any heat sources such as radiators, heat registers, stoves, or other apparatus (including amplifiers) that produce heat.
9. Do not defeat the safety purpose of the polarized or grounding-type plug. A polarized plug has two blades with one wider than the other. A grounding type plug has two blades and a third grounding prong. The wide blade or the third prong are provided for your safety. If the provided plug does not fit into your outlet, consult an electrician for replacement of the obsolete outlet.
10. Protect the power cord from being walked on or pinched particularly at plugs, convenience receptacles, and the point where they exit from the apparatus.
11. Only use attachments/accessories specified by the manufacturer.
12. Use only with the cart, stand, tripod, bracket, or table specified by the manufacturer, or sold with the apparatus. When a cart is used, use caution when moving the cart/apparatus combination to avoid injury from tip-over.

PORTABLE CART WARNING

S3125A
13. Unplug this apparatus during lightning storms or when unused for long periods of time.
14. Refer all servicing to qualified service personnel. Servicing is required when the apparatus has been damaged in any way, such as power-supply cord or plug is damaged, liquid has been spilled or objects have fallen into the apparatus, the apparatus has been exposed to rain or moisture, does not operate normally, or has been dropped.
15. Damage Requiring Service

Unplug the apparatus from the wall outlet and refer servicing to qualified service personnel under the following conditions:

 - A. When the power-supply cord or plug is damaged,
 - B. If liquid has been spilled, or objects have fallen into the apparatus,
 - C. If the apparatus has been exposed to rain or water,
 - D. If the apparatus does not operate normally by following the operating instructions. Adjust only those controls that are covered by the operating instructions as an improper adjustment of other controls may result in damage and will often require extensive work by a qualified technician to restore the apparatus to its normal operation,
- E. If the apparatus has been dropped or damaged in any way, and
- F. When the apparatus exhibits a distinct change in performance this indicates a need for service.
16. Object and Liquid Entry

Never push objects of any kind into the apparatus through openings as they may touch dangerous voltage points or short-out parts that could result in a fire or electric shock.

The apparatus shall not be exposed to dripping or splashing and no objects filled with liquids, such as vases shall be placed on the apparatus.

Don't put candles or other burning objects on top of this unit.
17. Batteries

Always consider the environmental issues and follow local regulations when disposing of batteries.
18. If you install the apparatus in a built-in installation, such as a bookcase or rack, ensure that there is adequate ventilation.

Leave 20 cm (8") of free space at the top and sides and 10 cm (4") at the rear. The rear edge of the shelf or board above the apparatus shall be set 10 cm (4") away from the rear panel or wall, creating a flue-like gap for warm air to escape.

Precautions

1. **Recording Copyright**—Unless it's for personal use only, recording copyrighted material is illegal without the permission of the copyright holder.
2. **AC Fuse**—The AC fuse inside the unit is not user-serviceable. If you cannot turn on the unit, contact your Onkyo dealer.

3. **Care**—Occasionally you should dust the unit all over with a soft cloth. For stubborn stains, use a soft cloth dampened with a weak solution of mild detergent and water. Dry the unit immediately afterwards with a clean cloth. Don't use abrasive cloths, thinners, alcohol, or other chemical solvents, because they may damage the finish or remove the panel lettering.

4. Power

WARNING

BEFORE PLUGGING IN THE UNIT FOR THE FIRST TIME, READ THE FOLLOWING SECTION CAREFULLY.

AC outlet voltages vary from country to country.

Make sure that the voltage in your area meets the voltage requirements printed on the unit's rear panel (e.g., AC 230 V, 50 Hz or AC 120 V, 60 Hz).

The power cord plug is used to disconnect this unit from the AC power source. Make sure that the plug is readily operable (easily accessible) at all times.

Some models have a voltage selector switch for compatibility with power systems around the world. Before you plug in such a model, make sure that the voltage selector is set to the correct voltage for your area.

Pressing the [**POWER**] button to select OFF mode does not fully disconnect from the mains. If you do not intend to use the unit for an extended period, remove the power cord from the AC outlet.

5. Preventing Hearing Loss

Caution

Excessive sound pressure from earphones and headphones can cause hearing loss.

6. Batteries and Heat Exposure

Warning

Batteries (battery pack or batteries installed) shall not be exposed to excessive heat as sunshine, fire or the like.

7. **Never Touch this Unit with Wet Hands**—Never handle this unit or its power cord while your hands are wet or damp. If water or any other liquid gets inside this unit, have it checked by your Onkyo dealer.

8. Handling Notes

- If you need to transport this unit, use the original packaging to pack it how it was when you originally bought it.
- Do not leave rubber or plastic items on this unit for a long time, because they may leave marks on the case.
- This unit's top and rear panels may get warm after prolonged use. This is normal.
- If you do not use this unit for a long time, it may not work properly the next time you turn it on, so be sure to use it occasionally.
- When you've finished using this unit, remove all discs and turn off the power.

9. Installing this Unit

- Install this unit in a well-ventilated location.
- Ensure that there's adequate ventilation all around this unit, especially if it's installed in an audio rack. If the ventilation is inadequate, the unit may overheat, leading to malfunction.
- Do not expose this unit to direct sunlight or heat sources, because its internal temperature may rise, shortening the life of the optical pickup.
- Avoid damp and dusty places, and places subject to vibrations from loudspeakers. Never put the unit on top of, or directly above a loudspeaker.
- Install this unit horizontally. Never use it on its side or on a sloping surface, because it may cause a malfunction.
- If you install this unit near a TV, radio, or VCR, the picture and sound quality may be affected. If this occurs, move this unit away from the TV, radio, or VCR.

10. Moisture Condensation

Moisture condensation may damage this unit.

Read the following carefully:

Moisture may condense on the lens of the optical pickup, one of the most important parts inside this unit.

- Moisture condensation can occur in the following situations:
 - The unit is moved from a cold place to a warm place.
 - A heater is turned on, or cold air from an air conditioner is hitting the unit.
 - In the summer, when this unit is moved from an air conditioned room to a hot and humid place.
 - The unit is used in a humid place.
- Do not use this unit when there's the possibility of moisture condensation occurring. Doing so may damage your discs and certain parts inside this unit. If condensation does occur, unplug the power cord and leave the unit for two to three hours in the room temperature.

This unit contains a semiconductor laser system and is classified as a "CLASS 1 LASER PRODUCT". So, to use this model properly, read this Instruction Manual carefully. In case of any trouble, please contact the store where you purchased the unit.

To prevent being exposed to the laser beam, do not try to open the enclosure.

CAUTION:

CLASS 1M VISIBLE AND INVISIBLE LASER RADIATION WHEN OPEN. DO NOT VIEW DIRECTLY WITH OPTICAL INSTRUMENTS. THIS PRODUCT UTILIZES A LASER. USE OF CONTROLS OR ADJUSTMENTS OR PERFORMANCE OF PROCEDURES OTHER THAN THOSE SPECIFIED HEREIN MAY RESULT IN HAZARDOUS RADIATION EXPOSURE.

The label on the right is applied on the rear panel.



1. This unit is a CLASS 1 LASER PRODUCT and employs a laser inside the cabinet.
2. To prevent the laser from being exposed, do not remove the cover. Refer servicing to qualified personnel.

For U.S. models

FCC Information for User

CAUTION:

The user changes or modifications not expressly approved by the party responsible for compliance could void the user's authority to operate the equipment.

NOTE:

This equipment has been tested and found to comply with the limits for a Class B digital device, pursuant to Part 15 of the FCC Rules. These limits are designed to provide reasonable protection against harmful interference in a residential installation.

This equipment generates, uses and can radiate radio frequency energy and, if not installed and used in accordance with the instructions, may cause harmful interference to radio communications. However, there is no guarantee that interference will not occur in a particular installation. If this equipment does cause harmful interference to radio or television reception, which can be determined by turning the equipment off and on, the user

is encouraged to try to correct the interference by one or more of the following measures:

- Reorient or relocate the receiving antenna.
- Increase the separation between the equipment and receiver.
- Connect the equipment into an outlet on a circuit different from that to which the receiver is connected.
- Consult the dealer or an experienced radio/TV technician for help.

For Canadian Models

NOTE:

THIS CLASS B DIGITAL APPARATUS COMPLIES WITH CANADIAN ICES-003.

For models having a power cord with a polarized plug:

CAUTION:

TO PREVENT ELECTRIC SHOCK, MATCH WIDE BLADE OF PLUG TO WIDE SLOT, FULLY INSERT.

Modèle pour les Canadien

REMARQUE:

CET APPAREIL NUMÉRIQUE DE LA CLASSE B EST CONFORME À LA NORME NMB-003 DU CANADA.

Sur les modèles dont la fiche est polarisée:

ATTENTION:

POUR ÉVITER LES CHOCS ÉLECTRIQUES, INTRODUIRE LA LAME LA PLUS LARGE DE LA FICHE DANS LA BORNE CORRESPONDANTE DE LA PRISE ET POUSSER JUSQU'AU FOND.

For British models

Replacement and mounting of an AC plug on the power supply cord of this unit should be performed only by qualified service personnel.

IMPORTANT

The wires in the mains lead are coloured in accordance with the following code:

Blue: Neutral

Brown: Live

As the colours of the wires in the mains lead of this apparatus may not correspond with the coloured markings identifying the terminals in your plug, proceed as follows: The wire which is coloured blue must be connected to the terminal which is marked with the letter N or coloured black.

The wire which is coloured brown must be connected to the terminal which is marked with the letter L or coloured red.

IMPORTANT

The plug is fitted with an appropriate fuse. If the fuse needs to be replaced, the replacement fuse must approved by ASTA or BSI to BS1362 and have the same ampere rating as that indicated on the plug. Check for the ASTA mark or the BSI mark on the body of the fuse.

If the power cord's plug is not suitable for your socket outlets, cut it off and fit a suitable plug. Fit a suitable fuse in the plug.

For European Models

Declaration of Conformity	
We, ONKYO EUROPE ELECTRONICS GmbH LIEGNITZERSTRASSE 6, 82194 GROEBENZELL, GERMANY	
declare in own responsibility, that the ONKYO product described in this instruction manual is in compliance with the corresponding technical standards such as EN60065, EN55013, EN55020 and EN61000-3-2, -3-3.	
GROEBENZELL, GERMANY	 K. MIYAGI
ONKYO EUROPE ELECTRONICS GmbH	

Features

- Plays Audio CD, CD-R, CD-RW, MP3 CD, and WMA CD*
- New circuit technology for Buffer Circuitry
- Separate Digital/Analog Circuitry
- Separate Massive Transformers for Digital and Analog Circuitry (Toroidal Transformer for Analog Circuitry)
- Thermally Regulated High-Precision Clock
- Silent Disc Mechanism with Solid Die-Cast Aluminum Tray
- Separate Anti-Vibration Aluminum Panels for Top, Front, and Sides
- New Circuit Board Construction to Reduce Vibration
- PLL Ultra Low Jitter Technology
- Separate TI (Burr-Brown) 192 kHz/24-Bit DACs (PCM1792) for L/R Channels
- Pure Analog Mode
- Transport Mode for Digital Output
- AES/EBU Balanced Digital Output with XLR Connector
- 3 Digital Outputs (Optical, Coaxial and AES/EBU)
- Gold-Plated, Machined Solid Brass, Wide Pitch Audio Outputs
- Display Dimmer (Normal/Dim/Off)

* Discs should be properly finalized.

Technologies

New circuit technology

Since the advent of digital audio, signal-to-noise ratios have improved dramatically. However, the S/N ratio reflects static noise only, and takes no account of another type of noise that occurs as the byproduct of sound reproduction—dynamic noise. To reduce this type of noise, Onkyo has developed New circuit technology for use in our hi-fi components. Despite being beyond the normal range of human hearing, frequencies above 100 kHz are susceptible to clock pulse and other forms of distortion from digital devices. Such distortion in the super-high-frequency range can generate “beat interference”, which in turn affects the character or atmosphere of the original sound. By improving linearity and reducing distortion in the super-high-frequency range, Onkyo’s new New circuit technology effectively reduces perceptible noise. New circuit technology is incorporated into the buffer circuitry of the C-7000R CD player.

Separate Digital/Analog Circuitry and Transformers

To prevent unwanted interference, the C-7000R employs physically separate circuitry for digital and analog processing. In the same vein, the player also features separate transformers for digital and analog circuitry.

Thermally Regulated Super-Precision Clock

The C-7000R boasts an extremely precise clocking mechanism that controls and coordinates the timing of all digital signal processes—rather like how a conductor directs and coordinates the individual instruments of an orchestra. The C-7000R uses a state-of-the-art crystal oscillator that achieves a frequency deviation of ± 1.5 ppm at room temperature—much lower than with a conventional oscillator. Even in surrounding temperatures of -30°C or $+80^{\circ}\text{C}$ the frequency remains stable, with only ± 0.5 ppm of additional frequency deviation.

PLL (Phase Locked Loop) Ultra-Low Jitter Technology

Jitter is an unwanted side-effect of the digital-to-analog conversion process caused by fluctuations in the time domain of a digital signal. PLL ultra-low jitter technology reduces jitter by comparing the input and output phases of the digital signal and creating an accurate clock waveform. This enhances the precision of digital signal processing and noticeably improves perceived audio quality.

New Circuit Board Construction

Rather than being directly connected to the chassis base, the circuit boards inside the C-7000R are cushioned by internal struts and affixed to the front, side, and rear panels. This method of construction prevents vibrations from the chassis from adversely affecting the circuit boards.

Block Diagram

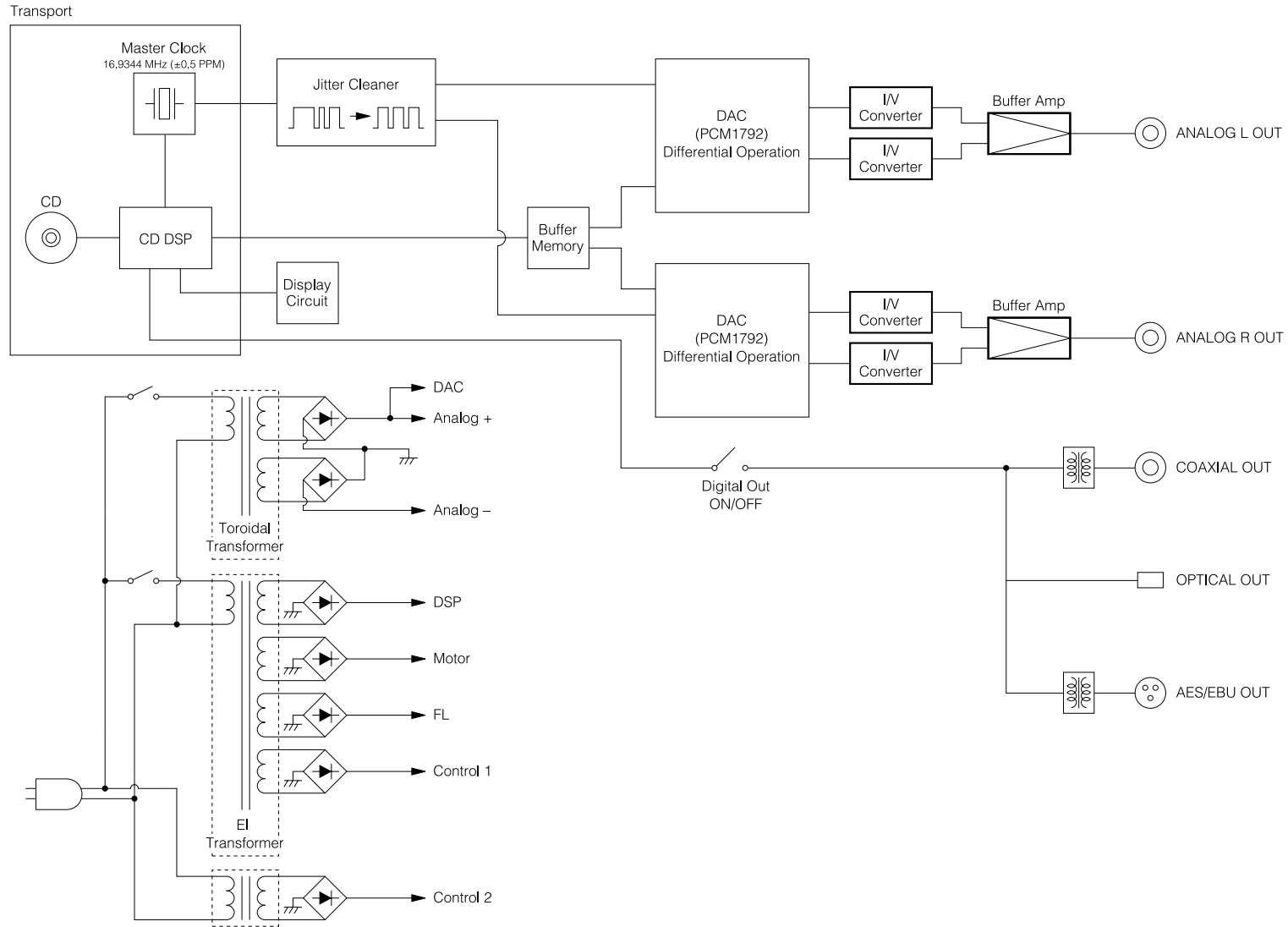

Supplied Accessories

Make sure you have the following accessories:

Remote controller and two batteries

- Remote controller (RC-796C) (1)
- Batteries (R03/AAA) (2)

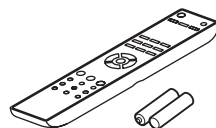

Power cord

- Power cord (1.8 m/5.9 ft) (1)
(Plug type varies from country to country.)

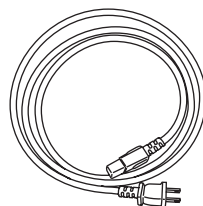

Audio connection cable

- Audio connection cable (0.8 m/2.6 ft) (1)

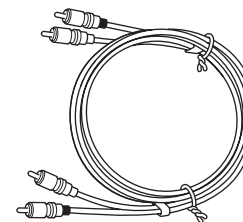

* In catalogs and on packaging, the letter at the end of the product name indicates the color. Specifications and operations are the same regardless of color.

Thank you for purchasing an Onkyo Compact Disc Player. Please read this manual thoroughly before making connections and plugging in the unit. Following the instructions in this manual will enable you to obtain optimum performance and listening enjoyment from your new Compact Disc Player. Please retain this manual for future reference.

Contents

Introduction

Important Safety Instructions	2
Precautions	3
Features	5
Technologies	6
Block Diagram	7
Supplied Accessories	8
Before Using the Compact Disc Player	10
Installing the Batteries	10
Using the Remote Controller	10
Installing the Compact Disc Player	10
Getting to Know the Compact Disc Player	11
Front Panel	11
Display	12
Rear Panel	13
Remote Controller	14
Disc Note	15

Connections

Connections	17
Cable and Jacks	17
Connecting the Power Cord.....	18
Connecting a Preamplifier or Integrated Amplifier	19

Turning On & Basic Operations

Basic Operations	21
Turning On/Off the Compact Disc Player	21
Playing the Disc	22
Selecting Files (MP3/WMA)	23
Setting the Display Brightness	24

Advanced Operations

Advanced Operations	25
Repeat Playback.....	25
Memory Playback (CD).....	26
Memory Playback (MP3/WMA).....	27
Random Playback.....	29
Selecting a Folder (Search Mode)	29
Displaying Disc Information	30

Custom Setup

Custom Setup	31
Setup Procedures	31
Preferences	31
Setting the Analog/Digital Output.....	32

Others

Troubleshooting	33
Specifications	35

Before Using the Compact Disc Player

Installing the Batteries

- 1 To open the battery compartment, press the small hollow and slide the cover.

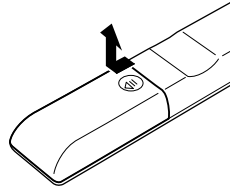

- 2 Insert the two supplied batteries (R03/AAA) in accordance with the polarity diagram inside the battery compartment.

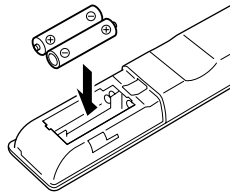

- 3 Replace the cover and slide it shut.

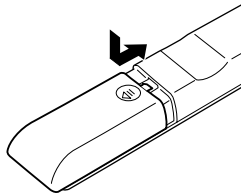

Note

- If the remote controller doesn't work reliably, try replacing the batteries.
- Don't mix new and old batteries or different types of batteries.
- If you intend not to use the remote controller for a long time, remove the batteries to prevent damage from leakage or corrosion.
- Remove expired batteries as soon as possible to prevent damage from leakage or corrosion.

Using the Remote Controller

To use the remote controller, point it at the compact disc player's remote control sensor, as shown below.

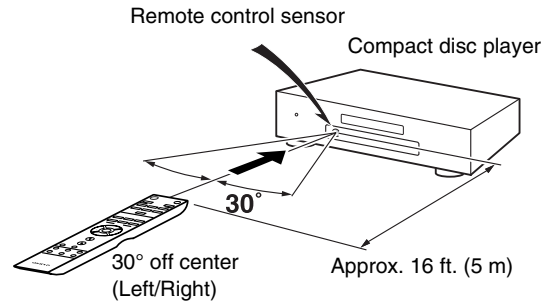

Note

- The remote controller may not work reliably if the compact disc player is subjected to bright light, such as direct sunlight or inverter-type fluorescent lights. Keep this in mind when installing.
- If another remote controller of the same type is used in the same room, or the compact disc player is installed close to equipment that uses infrared rays, the remote controller may not work reliably.
- Don't put anything, such as a book, on the remote controller, because the buttons may be pressed inadvertently, thereby draining the batteries.
- The remote controller may not work reliably if the compact disc player is installed in a rack behind colored glass doors. Keep this in mind when installing.
- The remote controller will not work if there's an obstacle between it and the compact disc player's remote control sensor.

Installing the Compact Disc Player

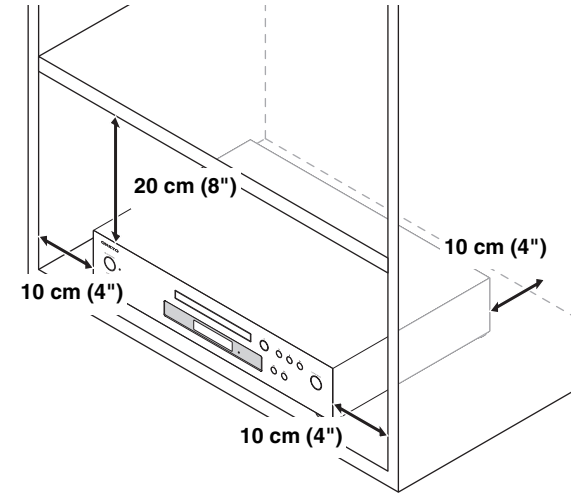

Install the compact disc player on a sturdy rack or shelf. Position it so that its weight is evenly dispersed on its four legs. Do not install the compact disc player in a place with vibration or an unstable location.

Getting to Know the Compact Disc Player

Front Panel

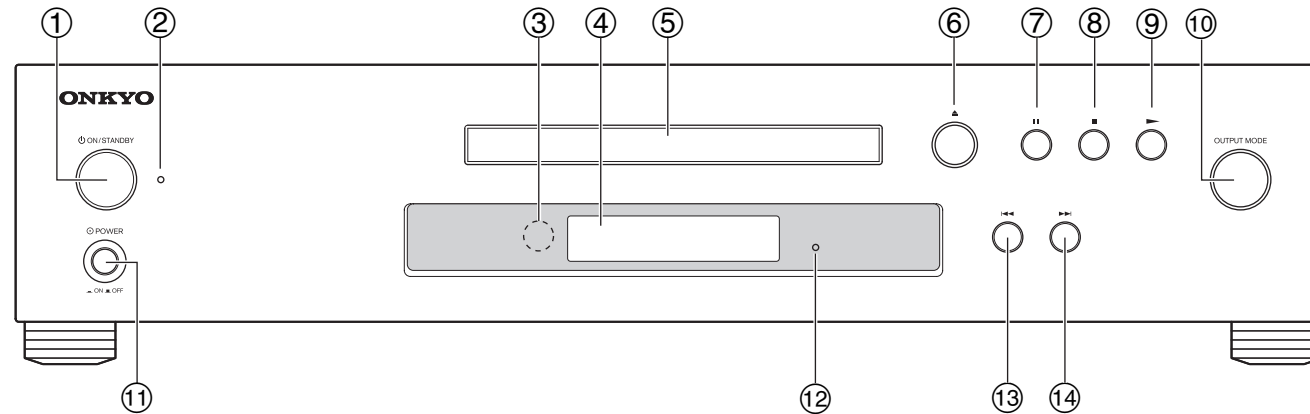

The page numbers in parentheses show where you can find the main explanation for each item.

① **ON/STANDBY button** (→ 21)

Use this button to set the compact disc player to On or Standby.

② **Standby LED** (→ 21)

Lights when the compact disc player is in Standby mode.

③ **Remote control sensor** (→ 10)

The sensor receives control signals from the remote controller.

④ **Display** (→ 12)

See “Display”.

⑤ **Disc tray** (→ 22)

Insert discs into this tray.

⑥ **▲ button** (→ 22)

Opens and closes the disc tray.

⑦ **|| button** (→ 22)

Use this button to pause disc playback. When paused, this resumes playback.

⑧ **■ button** (→ 22)

Use this button to stop disc playback.

⑨ **▶ button** (→ 22)

Use this button to play the disc.

⑩ **OUTPUT MODE button** (→ 32)

Use this button to switch the audio output signal between analog and digital (or both).

⑪ **POWER switch** (→ 21)

This is the main power switch. When set to the **OFF** position (■), the compact disc player is completely shutdown. It must be set to the **ON** position (▲) to set the compact disc player to On or Standby.

⑫ **Display Off LED** (→ 24)

Lights when the display is turned off. Before entering standby mode with the ASb function, the Display Off LED flashes 30 seconds before the ASb function starts running.

⑬ **◀◀ button** (→ 22)

Use this button to skip to the beginning of the track being played. Press and hold down to fast reverse.

⑭ **▶▶ button** (→ 22)

Use this button to skip to the beginning of the next track. Press and hold down to fast forward.

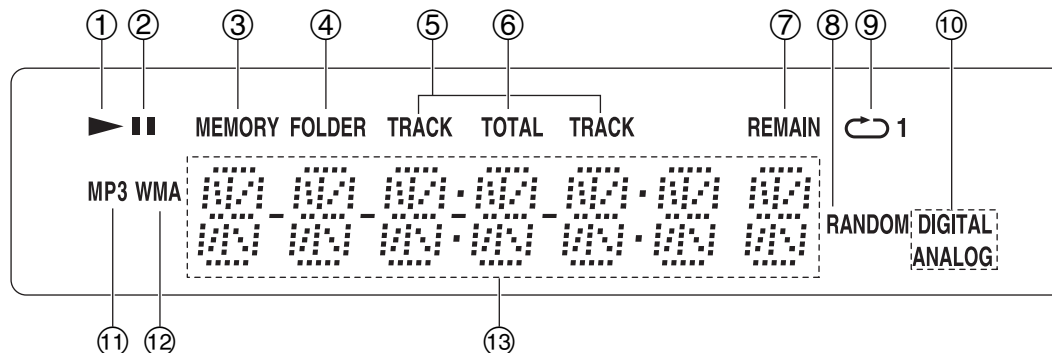

For detailed information, see the pages in parentheses.

- ① **▶ indicator (→ 22)**
Lights during playback.
- ② **|| indicator (→ 22)**
Lights when playback is paused.
- ③ **MEMORY indicator (→ 26, 27, 28)**
Lights during memory playback.
- ④ **FOLDER indicator (→ 23)**
Lights together with the folder name.
- ⑤ **TRACK indicator (→ 22)**
Lights together with the track number or file name.
- ⑥ **TOTAL indicator (→ 21)**
Lights when the total and remaining time of the track are shown.
- ⑦ **REMAIN indicator (→ 30)**
Lights when the remaining time of the track is shown.
- ⑧ **RANDOM indicator (→ 29)**
Lights during random playback.
- ⑨ **↺ 1 indicator (→ 25)**
Lights during repeat playback. “1” is shown when only the currently playing track is repeated.
- ⑩ **Audio output indicators**
Indicate the type of audio output (→ 32): **DIGITAL** and/or **ANALOG**.
- ⑪ **MP3 indicator (→ 21)**
Lights together with the folder name, file number or file name which contains MP3 tracks.
- ⑫ **WMA indicator (→ 21)**
Lights together with the folder name, file number or file name which contains WMA tracks.
- ⑬ **Message area**
Displays various information.

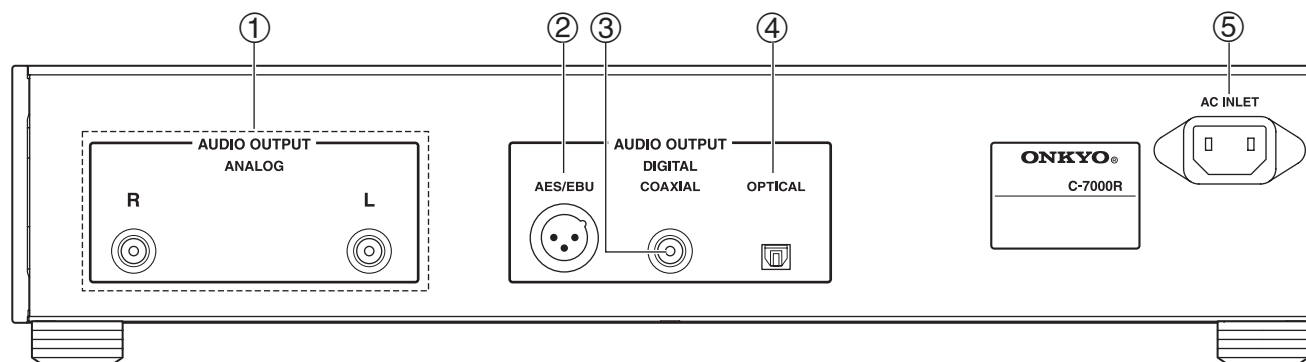

① **AUDIO OUTPUT ANALOG L/R jacks**

Connect the analog audio in jack of an amplifier or similar to this jack, using the supplied audio cable.

② **AUDIO OUTPUT DIGITAL AES/EBU jack**

This balanced AES/EBU output is for connecting a component with a balanced AES/EBU input.

③ **AUDIO OUTPUT DIGITAL COAXIAL jack**

This coaxial digital audio output is for connecting components with coaxial digital audio inputs, such as preamplifier.

④ **AUDIO OUTPUT DIGITAL OPTICAL jack**

This optical digital audio output is for connecting components with optical digital audio inputs, such as preamplifier.

⑤ **AC INLET**

The supplied power cord is connected here. The other end of the power cord should be connected to a suitable wall outlet.

See "Connections" for connection information
(→ 17 to 19).

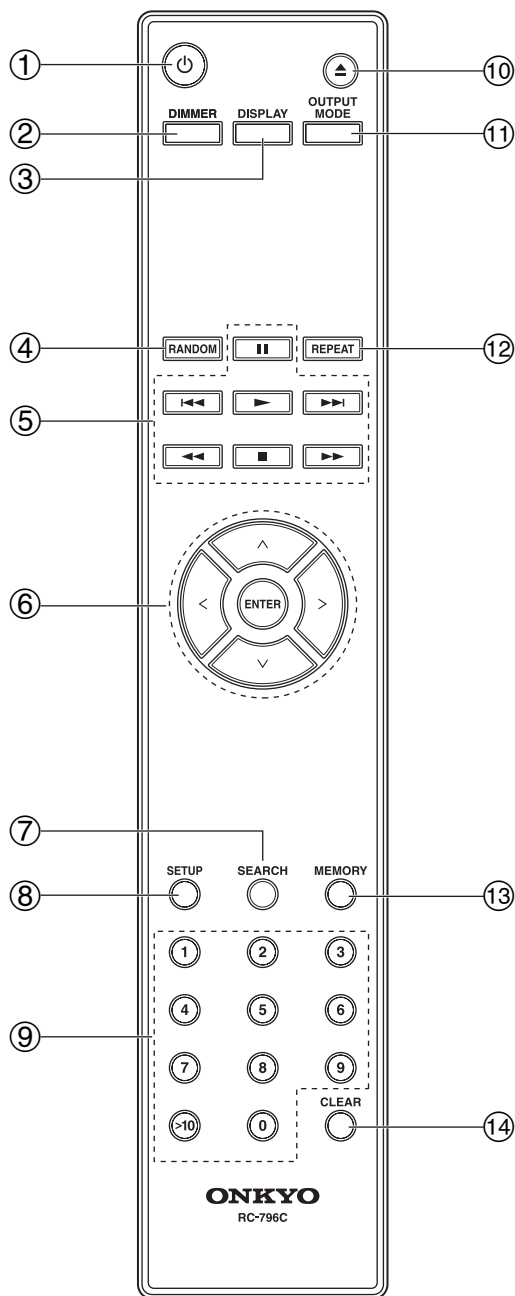



You can also use the remote controller to control your Onkyo C-7000R.
For detailed information, see the pages in parentheses.

- ① **⏻ button (→ 21)**
Sets the compact disc player to On or Standby.
- ② **DIMMER button (→ 24)**
Adjusts the display brightness.
- ③ **DISPLAY button (→ 30)**
Displays information about the current input source.
- ④ **RANDOM button (→ 29)**
Used with the random playback.
- ⑤ **Playback mode buttons (→ 22)**
 - ⏸ button**
Used to pause playback. When paused, this resumes playback.
 - ⏪ button**
Used to skip to the beginning of the track being played.
 - ▶ button**
Used to play the disc.
 - ⏩ button**
Used to skip to the beginning of the next track.
 - ⏮ button**
Used to fast reverse the current song.
 - button**
Used to stop disc playback.
 - ⏭ button**
Used to fast forward the current song.
- ⑥ **▲/▼/◀/▶ and ENTER buttons**
Used to select and adjust settings.
- ⑦ **SEARCH button (→ 28)**
Search for a folder on a disc containing MP3 or WMA tracks.
- ⑧ **SETUP button**
Used to change settings.
- ⑨ **Number buttons (→ 24)**
Used to select tracks and the like.
- ⑩ **▲ button (→ 22)**
Open and close the disc tray.
- ⑪ **OUTPUT MODE button (→ 32)**
Use this button to switch the audio output signal between analog and digital (or both).
- ⑫ **REPEAT button (→ 25)**
Used with the repeat playback.
- ⑬ **MEMORY button (→ 26, 27, 28)**
Used to begin or end memory playback.
- ⑭ **CLEAR button**
Used to clear any numbers that have been entered during numeric input. When making a memory setting, the selected track is erased.

Disc Note

Supported Discs

The compact disc player supports the following discs.

Audio CD		PCM
CD-R		Audio CD, MP3, WMA
CD-RW		Audio CD, MP3, WMA

- Do not use discs designed for purposes other than audio, such as CD-ROMs for PC use. Abnormal noise could damage the speakers or compact disc player.
- The compact disc player supports CD-R and CD-RW discs. Note that some discs may not playback because of the CD characteristics, scratches, contamination or the recording state. A CD recorded with an audio CD record will not playback unless it is finalized.
- Never use discs which have a special shape (such as hearts or octagons). These types of discs could jam and damage the compact disc player.



CD playback with copy-control function

Some audio CDs with copy-control function do not comply with official CD standards. These are special discs and cannot be played with this compact disc player.

Handling Discs

Hold discs by the edge, or by the center hold and edge. Avoid touching the playback surface (surface with nothing printed on it).

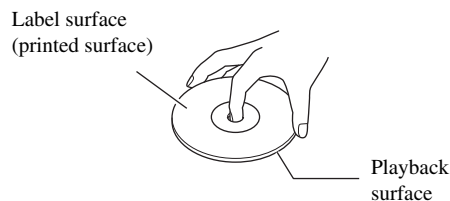

Do not attach paper or stickers, or write on the playback or label surface of the disc. Take care not to scratch or damage the disc.

Precautions for Rental Discs

Do not use discs with residue from cellophane tape, rental discs with labels which are peeling off, or discs with decorative labels. This type of disc could get stuck in the compact disc player, or could damage the compact disc player.

Precautions for Inkjet Printable Discs

Do not leave a CD-R/CD-RW having a label printed with an inkjet printer in the compact disc player for a long time. The disc could get stuck in the compact disc player, or could damage the compact disc player.

Remove the disc from the compact disc player when not being played, and store it in a case. A freshly printed disc will stick easily, and should not be played immediately.

Caring for Discs

If the disc is dirty, the compact disc player will have a hard time reading signals, and the audio quality may drop. If the disc is dirty, gently wipe off fingerprints and dust with a soft cloth. Lightly wipe from the center outwards.

To remove stubborn dust or dirt, wipe the disc with a soft cloth dampened with water, and then dry it with a dry cloth. Do not use cleaning spray for analog records or antistatic agents, etc.



Never use volatile chemicals such as benzine or paint thinner as they can impregnate the disc surface.

About the Condensation

Moving the compact disc player from a cold room into a warm room, or heating a cold room with a heater may cause waterdrops to form inside the compact disc player. This is called condensation. Not only does this cause malfunction, but it can also damage the compact disc player or any inserted disc. Remove discs from the compact disc player when not in use.

If condensation appears, unplug the power cord and leave the compact disc player more than 3 hours at room temperature.

Playback of MP3 and WMA CDs

MP3 and WMA files recorded on a CD-R/CD-RW can be played with this compact disc player.

- Use discs which have been recorded following the ISO9660 Level 2 file system. (The supported directory depth is eight levels, the same as ISO9660 Level 1)
Discs recorded with the hierarchical file system (HFS) cannot be played.
- Always close the disc tray.

Note

- A disc recorded with a recorder or personal computer may not play in some cases. (Cause: Disc's characteristics, damaged or dirty disc, dirt on player's lens, dew condensation, etc.)
- A disc recorded on a personal computer may not play because of the application settings or environment. Record the disc with the proper format. (Contact the application maker for details.)
- A disc with insufficient storage capacity may not play back properly.

Playback of MP3 CDs









- Only MP3 files with the extension “.MP3” or “. mp3” are supported.
- This compact disc player supports files recorded in MPEG 1 Audio Layer 3 (32-320 kbps), with the sampling frequency of 32/44.1/48 kHz.
- Variable bitrates (VBR) between 32 kbps and 320 kbps are supported. The time information during VBR playback may not display correctly.

Playback of WMA CDs

- WMA stands for “Windows Media® Audio”, an audio compression technology developed by Microsoft Corporation USA.
 - Only WMA files with the extension “.WMA” or “.wma” are supported.
 - Encode the WMA file with an application approved by Microsoft Corporation USA. The file may not playback correct if encoded with an unapproved application.
 - Variable bitrates (VBR) between 32 kbps and 192 kbps (32/44.1/48 kHz) are supported.
 - Copyright-protected WMA files cannot be played back.
 - WMA Pro, Lossless and Voice are not supported.
- * Windows Media is a registered trademark or trademark of Microsoft Corporation in the United States and/or in other countries.

Connections

Cable and Jacks

Balanced AES/EBU		 AES/EBU	This is a professional digital audio interface. Balanced AES/EBU cables are used for better noise immunity and longer cable runs. The maximum sampling rate for PCM output is 44.1 kHz/16 bit, 2ch.
Optical digital audio		 OPTICAL	Optical digital connections allow you to enjoy digital sound. The maximum sampling rate for PCM input is 44.1 kHz/16 bit, 2ch.
Coaxial digital audio		 COAXIAL Orange	Coaxial digital connections allow you to enjoy digital sound. The maximum sampling rate for PCM input is 44.1 kHz/16 bit, 2ch.
Analog audio (RCA)		L  R  White Red	Analog audio connections (RCA) carry analog audio.

Note

- Push plugs in all the way to make good connections (loose connections can cause noise or malfunctions).

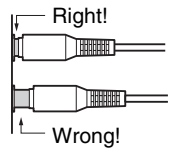

- To prevent interference, keep audio cables away from power cords and speaker cables.
- The compact disc player's optical digital jack has a shutter-type cover that opens when an optical plug is inserted and closes when it's removed. Push plugs in all the way.
- To prevent shutter damage, hold the optical plug straight when inserting and removing.
- The analog audio cable can be used instead of the coaxial cable.

About Balanced Output (AES/EBU Jack)

Plugging the AES/EBU cable

Match the pins and insert the jack until you hear a “click.” Make sure that the jack is locked by lightly pulling the connection cable.

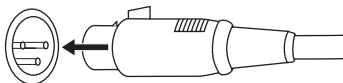

Unplugging the AES/EBU cable

Pull out the connection cable while holding down the button.

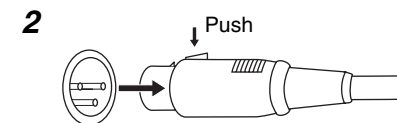
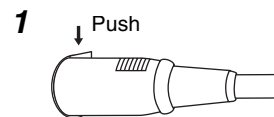

Connecting the Power Cord

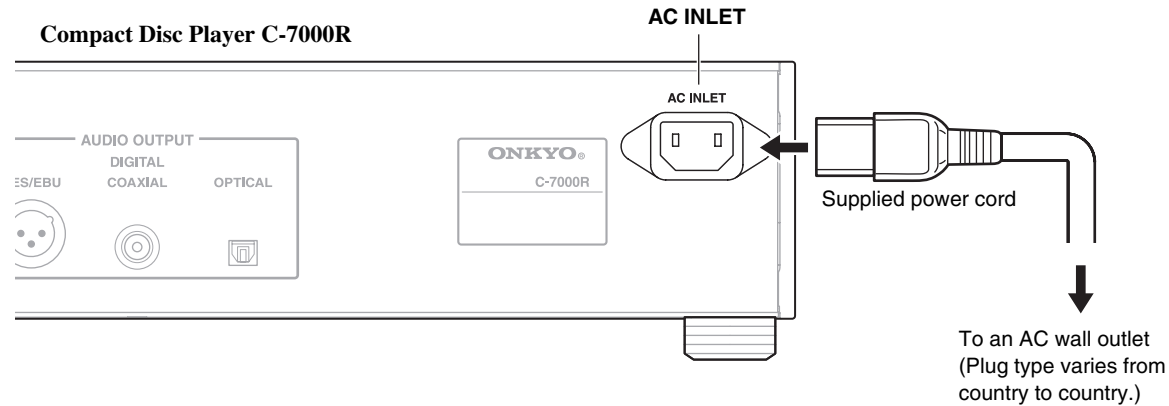

- 1** Make sure that the main power of the compact disc player is turned off.
- 2** Connect all of your components.
- 3** Connect the supplied power cord to the compact disc player's **AC INLET**.
- 4** Plug the power cord into an AC wall outlet.

Tip

- To reduce noise, do not tie the signal cable and power cable together. Wire them so that they are away from each other.

Note

- **Never disconnect the power cord from the compact disc player while the other end is still plugged into a wall outlet.** Doing so may cause an electric shock. Always disconnect the power cord from the wall outlet first, and then the compact disc player.
- Turning on the compact disc player may cause a momentary power surge that might interfere with other electrical equipment on the same circuit. If this is a problem, plug the compact disc player into a different branch circuit.
- Do not use a power cord other than the one supplied with the compact disc player. The supplied power cord is designed exclusively for use with the compact disc player and should not be used with any other equipment.

Connecting a Preamp or Integrated Amplifier

Analog Connection

Preamplifier P-3000R

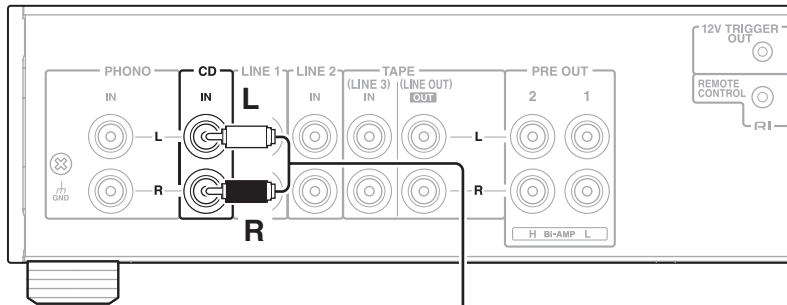

Compact Disc Player C-7000R

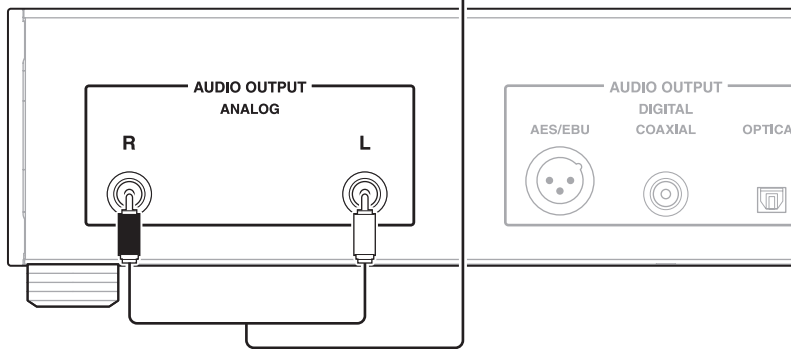

This is an example of analog connection using the preamplifier P-3000R.

Digital (Optical or Coaxial) Connection

Preamp P-3000R

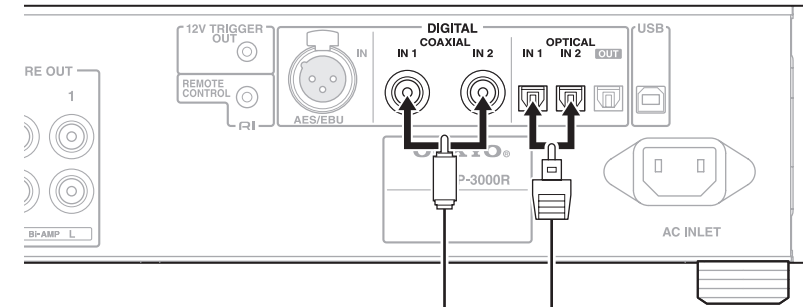

Connect either of them.

Compact Disc Player C-7000R

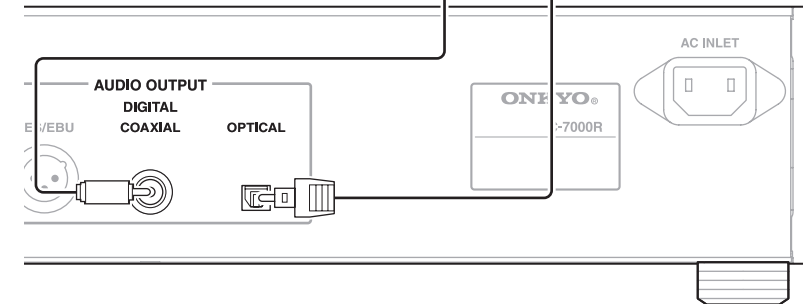

This is an example of digital connection using the preamp P-3000R.
Connect either of them.

Preamplifier P-3000R

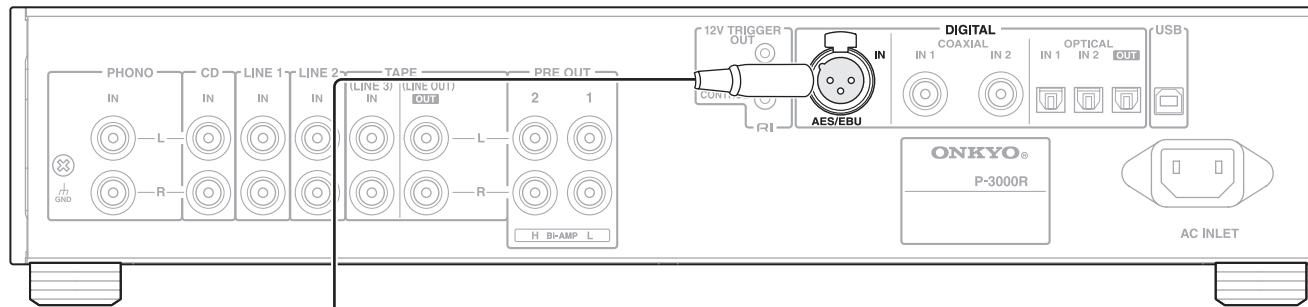

Compact Disc Player C-7000R

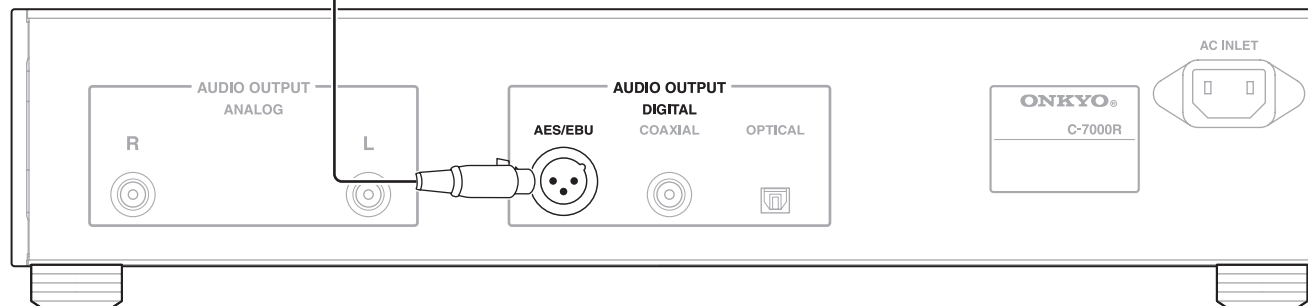

This is an example of AES/EBU connection using the preamplifier P-3000R.

Basic Operations

Turning On/Off the Compact Disc Player

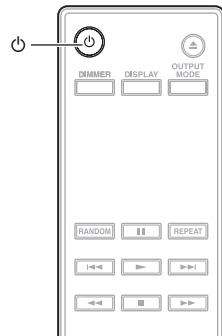
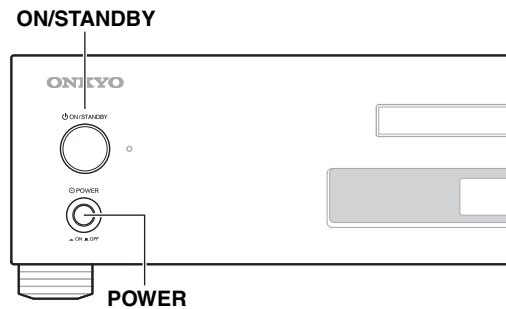

Turning On the Compact Disc Player

- 1 Set **POWER** to the **ON** position (⏻) on the front panel.
- 2 Press ⏻ to turn on the compact disc player.
The compact disc player comes on, the display lights, and the Standby LED goes off.

You can also use compact disc player's **ON/STANDBY**.

(Audio CD Display)

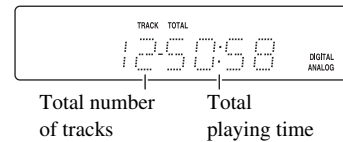

(MP3/WMA Display)

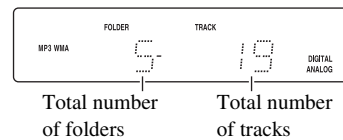

Q Tip

- After a certain period of warming up, the temperature of the compact disc player's components and internal temperature are stabilized, and the sound will soften.

Note

- If the message "NO DISC" appears on the display, no disc information is available.
- The compact disc player remembers the state when power was previously turned OFF, and returns to the state.

Turning Off the Compact Disc Player

- 1 Press ⏻ to set the compact disc player to Standby.
The compact disc player will enter Standby mode, and the Standby LED lights.

You can also use compact disc player's **ON/STANDBY**.
- 2 To completely shut down the compact disc player, set **POWER** to the **OFF** position (⏻).

Note

- See "Custom Setup" for the auto standby function (→ 32).

Playing the Disc

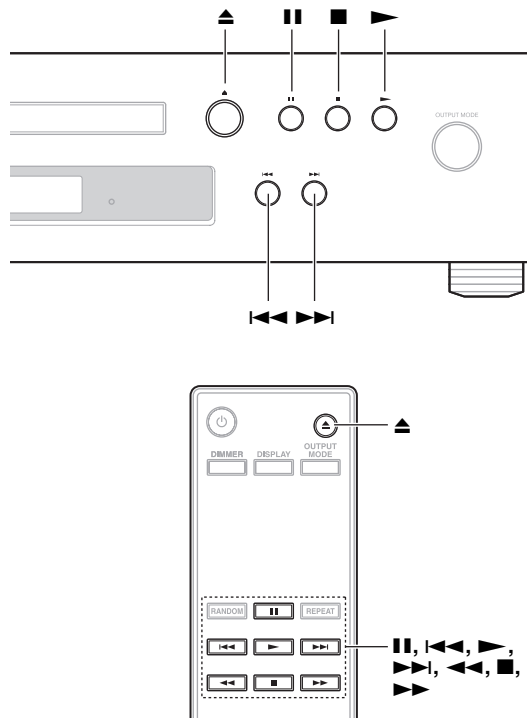

1 Press ▲ to open the disc tray.

Pressing ▲ while the compact disc player is on Standby will turn on the compact disc player and open the disc tray.

2 Place the disc on the tray with the label-side facing up.

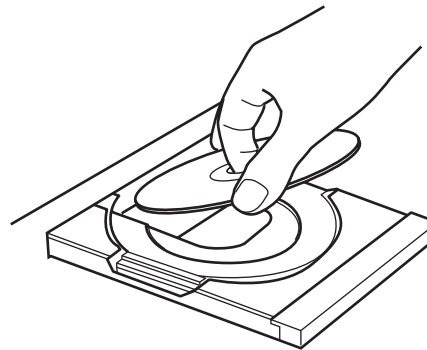

When you want listening to the 8 cm disc, place it in the center of the tray.

3 Press ► to start playback.

The disc tray closes and playback starts.

(Audio CD Display)

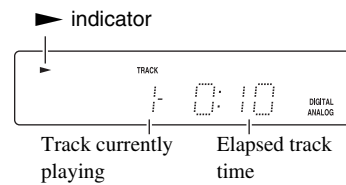

(MP3/WMA Display)

File name will be displayed by scrolling.

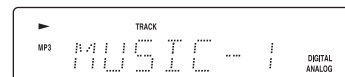

Q Tip

- Only alphanumeric characters in MP3/WMA CD information are displayed correctly. Double-byte characters and other characters appear as underscores.
- If a disc has been set in the tray, when the power of the compact disc player is turned on, then it starts to play automatically.

■ To Select Tracks

Press ►► to select the next track/file or ◀◀ to select the previous track/file.

- If you press ◀◀ during playback or while playback is paused, the beginning of the current track/file is selected.
- If you select a track/file while playback is stopped, press ► to start playback.
- When ◀◀/►► are pressed, the following Disc information is displayed for MP3/WMA.
(During playback) File number/File name → File name → File number/playing time
(Paused) File number/File name → File name → Folder number/File number

■ To Fast-Forward or Fast-Reverse

During playback or while playback is paused, hold down ►► to fast-forward or ◀◀ to fast-reverse.

■ To Pause Playback

During playback, press ||. The || indicator lights. To resume playback, press ► or || again.

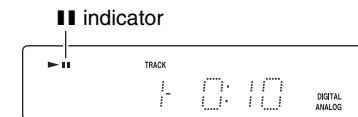

■ To Stop Playback

Press ■ to stop playback.

■ To Eject the Disc

Press ▲ to open the disc tray.

📄 Note

- For MP3/WMA CDs, you can select MP3/WMA files in other folders.

Selecting Files (MP3/WMA)

For MP3/WMA CDs, files (MP3/WMA files) may be organized in a hierarchically, with folders containing files and subfolders, as shown below.

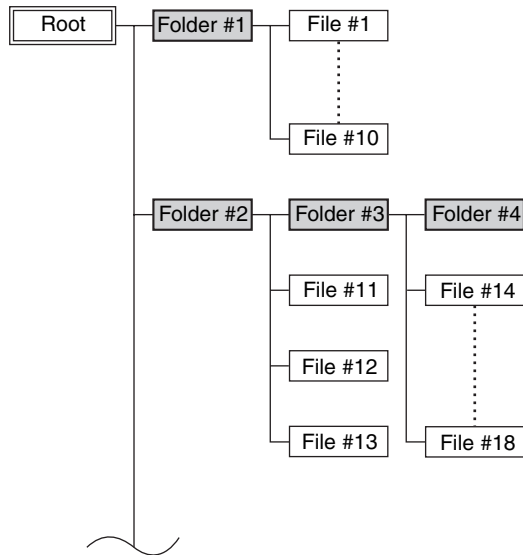

In this manual, MP3/WMA files are referred to as files. Likewise, folders (directories) are referred to as folders.

For the compact disc player, there are two modes for selecting files (MP3/WMA files): Navigation mode and All Folder mode.

In Navigation mode, you can select files (MP3/WMA files) by navigating through the folder hierarchy, moving in and out of folders and subfolders.

In All Folder mode, all folders appear at the same level, making it easy to select folders regardless of the hierarchy.

Note

- If you don't select a specific MP3/WMA file or folder for playback, all of the MP3/WMA files on the disc will be played in numerical order starting with file #1 in parentheses.

Selecting Files in Navigation Mode

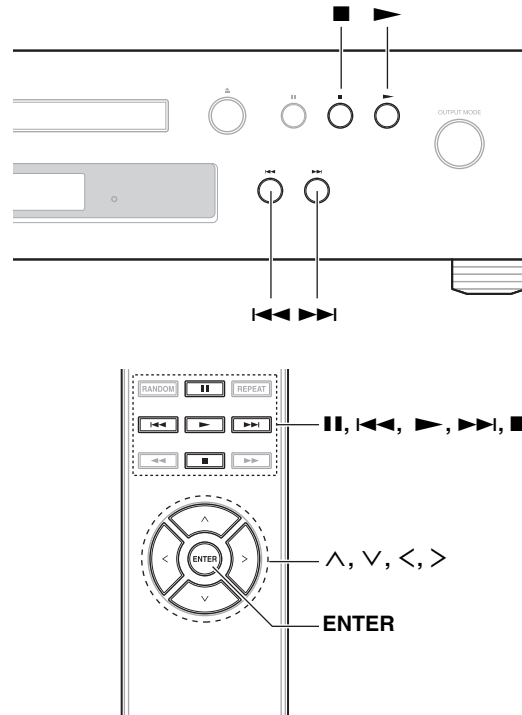

In Navigation mode, you can select files by navigating through the folder hierarchy. This mode can only be used while playback is stopped.

1 While playback is stopped, press ∇ or \blacksquare .

The compact disc player enters Navigation mode and "[ROOT]" appears on the display.

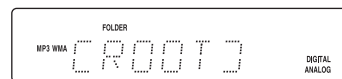

2 Press ∇ or ENTER (front panel: \blacktriangleright).

The first folder name in ROOT appears on the display. If the disc contains no folders, the first file name appears.



3 Use \langle / \rangle or $\blacktriangleleft / \blacktriangleright$ to select other folders and files at the same level. To move up a level, press \blacktriangle or \blacksquare (front panel: \blacksquare).

Folders that don't contain files or subfolders can't be selected.

4 Press ENTER or ∇ to move down a level (front panel: \blacktriangleright).

5 Use \langle / \rangle or $\blacktriangleleft / \blacktriangleright$ to select a file in the folder.

6 Press ENTER or \blacktriangleright .

Playback will start with the specified file or folder and continue until all of the files on the disc have been played.

To cancel the procedure at any point, press \blacksquare on the remote controller.

Note

- The behavior of \blacksquare on the compact disc player can be set from "STOP KEY" (\rightarrow 32).

Selecting Files in All Folder Mode

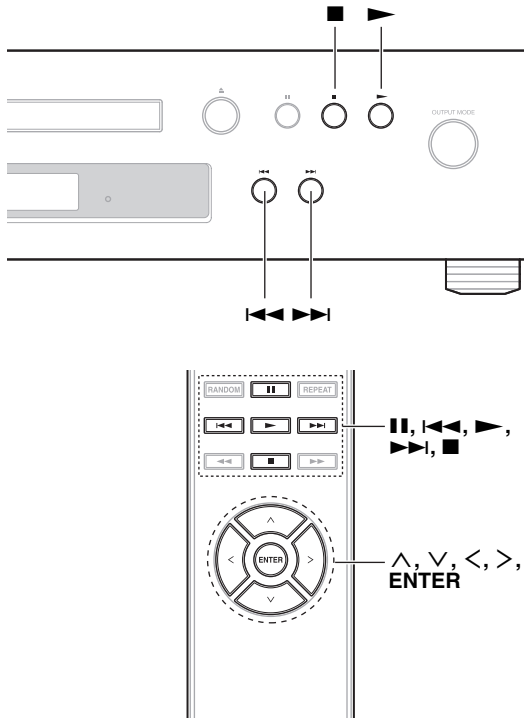

In All Folder mode, you don't have to navigate the folder hierarchy because all folders that contain files appear at the same level. This mode can only be used while playback is stopped.

1 While playback is stopped, press \wedge or II (front panel: press and hold \blacksquare).

The compact disc player enters All Folder mode, and "1-" appears on the display.

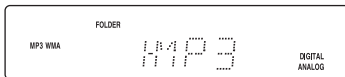

2 Use \langle / \rangle or $\text{I} \ll / \gg \text{I}$ to select the other folders. You can select any folder that contains files.

3 Press \vee (front panel: \blacktriangleright).

The first file name inside the folder appears.

Use \langle / \rangle or $\text{I} \ll / \gg \text{I}$ to select the files within the folder.

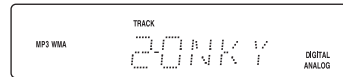

To select another folder, press \blacksquare again (front panel: \blacksquare), and then use $\text{I} \ll / \gg \text{I}$ to select it.

4 Press ENTER or \blacktriangleright to start playback.

Playback will start with the specified file or folder and continue until all of the file on the disc have been played.

To cancel the procedure at any point, press \blacksquare .

To Select Folders and Files by Number

1. Use the number buttons as shown in the examples below to enter folder/file numbers.

To select:	Press:
Folder/File #8	8
Folder/File #10	0
Folder/File #34	<-10 3 4

<-10 Used to enter numbers over 10.

2. Playback starts. When you enter folder number, playback will start from the first file in the selected folder. If a folder contains more than 99 files, single- and double-digit file numbers must be preceded by zeros. For example, to specify file #8, press 8. To specify file #34, press >10 , 3, and 4. To specify file #134, press >10 , 1, 3, and 4.

Note

- The behavior of \blacksquare on the compact disc player can be set from "STOP KEY" (\rightarrow 32).

Setting the Display Brightness

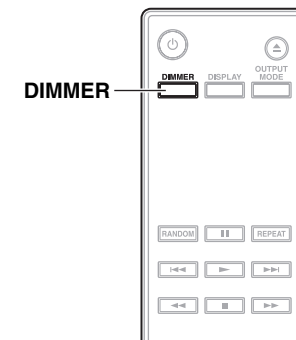

You can adjust the brightness of the compact disc player's display.

1 Press DIMMER repeatedly to change the brightness of the display in sequence.

Normal \rightarrow Dim \rightarrow Off

Normal

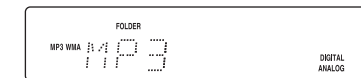

Dim



Off

The Display Off LED lights.

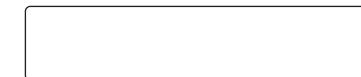

Note

- The display lights for a 5 seconds if you control any buttons on the front panel or remote controller when the display brightness is set to OFF.

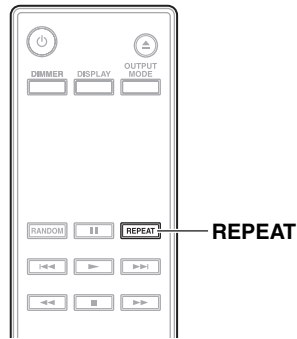

Advanced Operations

Repeat Playback



In repeat playback, you can play an entire disc repeatedly, play one track repeatedly, or combine it with memory playback to play the playlist repeatedly, or random playback to play all of the tracks on the disc in random order repeatedly.

- 1 Press **REPEAT** repeatedly to select Repeat All, Repeat 1 or Repeat Off.

The “” or “ 1” indicator lights.

Repeat All → Repeat 1 → Repeat Off

Repeat All



Repeat 1

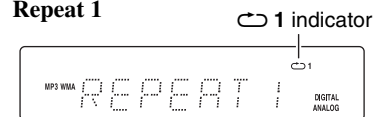

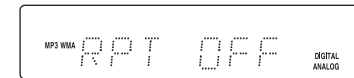

Repeat Off





Repeat-1 playback can't be combined with memory playback, random playback.

- 2 To cancel repeat playback, press **REPEAT** repeatedly until the “RPT OFF” appears.

The “” or “ 1” indicator goes off.

Q Tip

- Repeat playback is cancelled when you press  to open the disc tray.
- Repeat playback is cancelled when you press  or **ON/STANDBY** to turn off the compact disc player.

Memory Playback (CD)

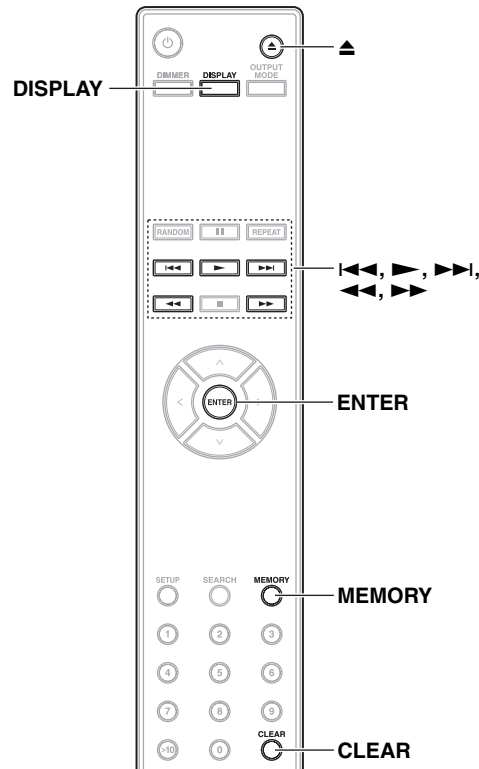

In memory playback, you can create a playlist of up to 25 tracks. Memory playback can be set only when the playback is stopped.

- 1 Press **MEMORY**.
The **MEMORY** indicator lights.

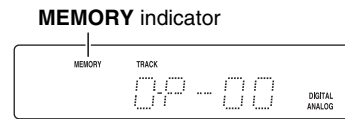

- 2 Use **◀◀/▶▶** to select the first track you want to add to the playlist, and then press **▶** or **ENTER**.

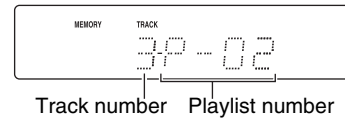

Repeat this step to add additional tracks to the playlist. You can alternatively use the number buttons to select tracks.

- 3 Press **ENTER** or **▶**.
The memory playback starts.

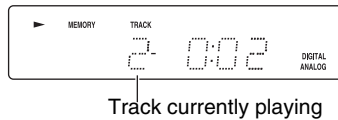

■ To Change the Display

While the memory setting operations, press **DISPLAY** repeatedly to change the display information as follows:
Track number/Playlist number → Track number/Playing time → Track number/Total playing time

■ To Select Other Tracks During Memory Playback

Use **◀◀/▶▶** to select other tracks during memory playback.

■ To Check the Playlist

While playback is stopped, use **◀◀/▶▶** to scroll through the playlist. Track number and play time are displayed.

■ To Remove Tracks from the Playlist

- While memory playback is stopped, press **CLEAR**. Each press removes the last track from the playlist.
- The playlist is deleted on changing the playback mode (press **MEMORY** after stopping the playback).

■ To Cancel Memory Playback

- Stop the playback, then press **MEMORY** to change the playback mode. The **MEMORY** indicator goes off, and memory playback is cancelled.
- Memory playback is also cancelled by pressing **▲** to open the disc tray, **⏻** or **ON/STANDBY** to turn off the compact disc player.

📄 Note

- If the total playing time is more than 99 minutes and 59 seconds, "--:--" appears.
- You can add up to 25 tracks to the playlist. If you try to add more, the message "**MEM-FULL**" appears.

Memory Playback (MP3/WMA)

Memory Playback in Navigation Mode

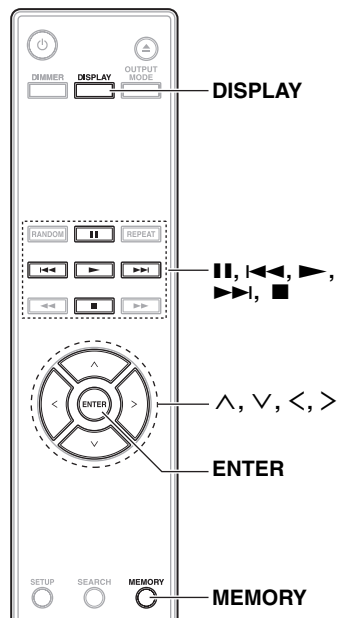
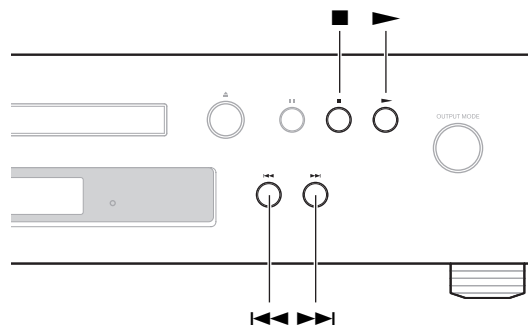

In memory playback, you can create a playlist of up to 25 files. Memory playback can be set only when the playback is stopped.

1 Press **MEMORY**.

The **MEMORY** indicator lights.

2 Press **∨** or **■**.

The compact disc player enters Navigation mode and “[ROOT]” appears on the display.

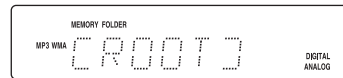

3 Press **∨** or **ENTER** (front panel: **▶**).

The first folder name in ROOT appears on the display.

4 Use **</>** or **◀◀/▶▶** to select other folders and files at the same level.

Folders that don't contain files or subfolders can't be selected.

5 Press **ENTER** or **∨** to move down a level (front panel: **▶**).

6 Use **</>** or **◀◀/▶▶** to select a file in the folder.

7 Press **▶**.

The first file is memorized in the playlist.

8 Use **</>** or **◀◀/▶▶** to continue selecting the memory file.

To move up a level, press **∧** or **■** (front panel: **■**).

To continue selecting the memory file, repeat steps 4 to 7.

To memorize other files of the same folder in the playlist, use **◀◀/▶▶** to select files, then press **▶**.

9 Press **ENTER** or **▶**.

Memory playback starts.

■ To Change the Display

While the memory setting operations, press **DISPLAY** to change the display information as follows:

File name → Folder name → Folder number/File number

📄 Note

- See “Selecting Files (MP3/WMA)” for the Navigation Mode information (→ 23).
- The behavior of **■** on the compact disc player can be set from “STOP KEY” (→ 32).
- Memory playback is cancelled when you press **▲** to open the disc tray.
- Memory playback is cancelled when you press **⏻** or **ON/STANDBY** to turn off the compact disc player.

Memory Playback in All Folder Mode

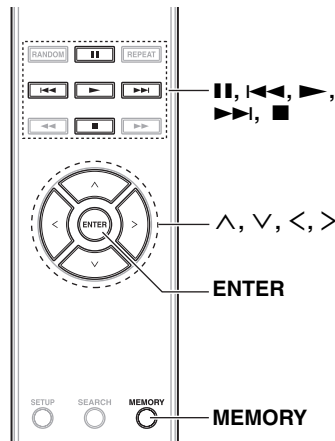
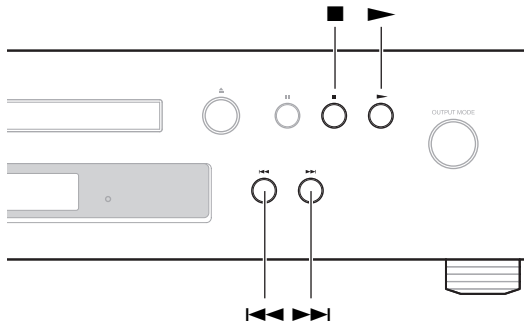

1 Press MEMORY.

The MEMORY indicator lights.

2 Press ^ or ■ (front panel: press and hold ■).

The compact disc player enters All Folder mode and “1-” appears on the display.

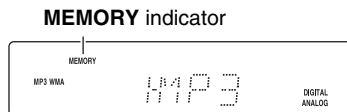

3 Use </> or |◀◀/▶▶| to select the folders.

4 Press ∨ (front panel: ▶).

5 Use </> or |◀◀/▶▶| to select the files.

6 Press ▶ to memorized the first file.

7 Press ■ (front panel: ■), then repeat steps 3 to 6.

To memorize other files of the same folder in the playlist, repeat steps 5 to 6.

8 Press ENTER (front panel: ▶).

Memory playback starts.

Note

- See “Selecting Files (MP3/WMA)” for the All Folder Mode information (→ 24).
- The behavior of ■ on the compact disc player can be set from “STOP KEY” (→ 32).
- Memory playback is cancelled when you press ▲ to open the disc tray.
- Memory playback is cancelled when you press ⏻ or ON/STANDBY to turn off the compact disc player.

Random Playback

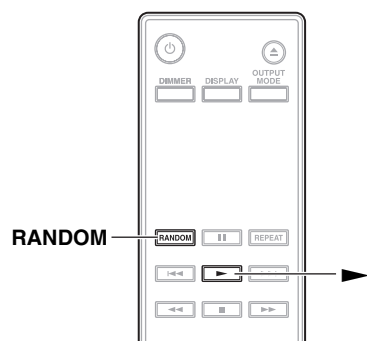

In random playback, all of the files on the disc are played in random order. This mode can only be used while playback is stopped.

1 While playback is stopped, press **RANDOM**.

The **RANDOM** indicator lights.

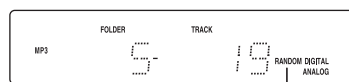

RANDOM indicator

2 Press **▶**.

The random playback starts.

3 To cancel random playback, stop the playback, then press **RANDOM** to change the playback mode.

The **RANDOM** indicator goes off, and random playback is cancelled.

If you press **RANDOM** during playback, the message “**NOR PLY**” (Normal play) is displayed.

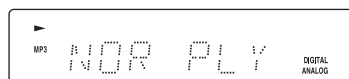

Q Tip

- Random playback is cancelled when you press **▲** to open the disc tray.
- Random playback is cancelled when you press **⏻** or **ON/STANDBY** to turn off the compact disc player.

Selecting a Folder (Search Mode)

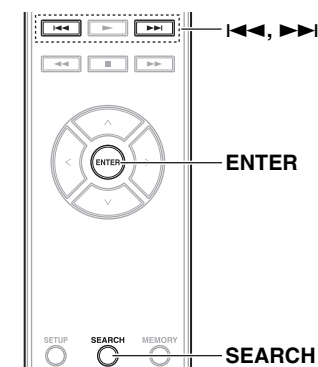

This section explains how to select MP3/WMA folders during Playback.

1 During playback, press **SEARCH**.

The compact disc player enters All Folder mode and folders are displayed.

2 To select the previous folder, press **◀◀**. To select the next folder, press **▶▶**.

You can also use the number buttons to select the folder.

3 Press **ENTER** or **▶**.

Playback will start from the first file in the selected folder.

Note

- **SEARCH** cannot be used during Random Playback and Memory Playback (→ 26, 29).
- See “Selecting Files in All Folder Mode” to select folder by number (→ 24).

Displaying Disc Information

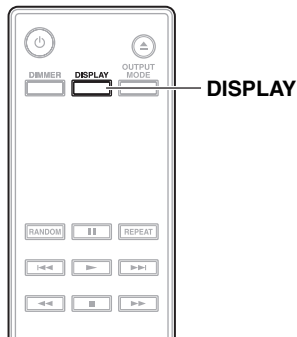

- 1 Press **DISPLAY** repeatedly to show the following disc information.

While playback is stopped

(Audio CD Display)

Track and total playing time appears on the display.

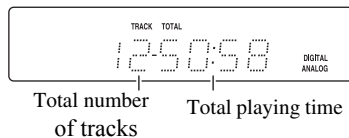

(MP3/WMA Display)

The name of disc appears on the display.

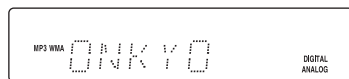

During playback or pause

(Audio CD Display)

Elapsed file time:

The length of time that the current file has been playing (default display).

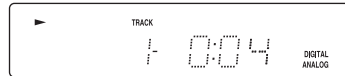

Remaining file time:

The amount of time remaining for the current file (**REMAIN** indicator appears).

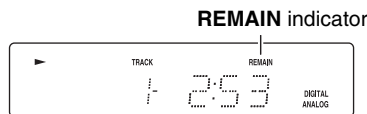

Remaining disc time:

The amount of time remaining for the entire disc (**TOTAL** and **REMAIN** indicators appear).

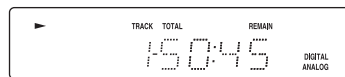

(MP3/WMA Display)

You can display various information about the MP3/WMA file currently playing, including ID3 tags such as title name, artist name, and album name.

Elapsed file time:

The length of time that the current file has been playing (default display).

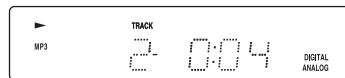

File name:

Name of the current file.

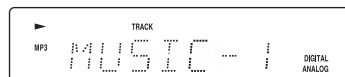

Folder name:

Name of the current folder.



Title name:

Title of the current file (if ID3 tag present). When there is no ID3 tag, the message “**TITLE-NO DATA**” appears.

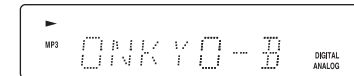

Artist name:

Name of the Artist (if ID3 tag present).

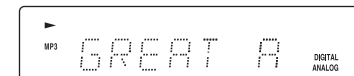

Album name:

Name of the album (if ID3 tag present).

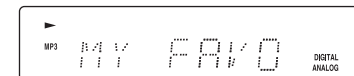

Sampling rate and bit rate:

Sampling rate and bit rate of the current file.

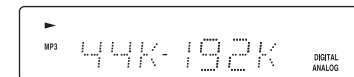

Note

- To display the disc name, press **DISPLAY** while playback is stopped.
- If a file or folder name contains any characters that cannot be displayed, an underscore will appear in place of those characters. Alternatively, you can set the compact disc player so that names containing such characters are displayed as “FILE n” or “FOLDER n”, “n” being the file or folder number. See “**BAD-NAME**” for undisplayable characters setting (→ **31**).

Custom Setup

Setup Procedures

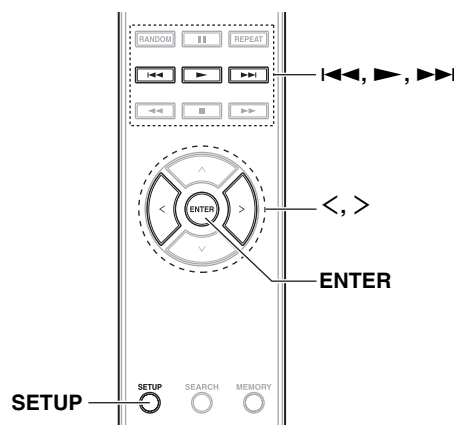

1 Press **SETUP**.

2 Use **</>** or **◀▶** to select the preference you want to change.

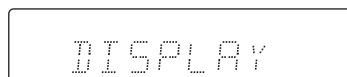

The preferences are explained in the next column.

3 Press **ENTER** or **▶**.

4 Use **</>** or **◀▶** to select the preference's options.

5 Press **ENTER** or **▶**.

When the preference has been set, "FINISH" appears on the display.

To cancel the procedure at any point, press **SETUP**.

Preferences

AUDIO

■ FILTER

▶ **SHARP** (default)

This preference allows the band property up to 20 kHz to be output almost flat.

▶ **SLOW**

This preference brings higher reproducibility of input waveform, and is suitable to reproduce agogics, or subtle attack of sound signals, along with sound image localization for each musical instrument.

This preference configures the setting to switch the characteristics of the digital filter for D/A conversion. You can opt for whichever of the characteristics that vary depending on your switching.

■ PHASE

▶ **NORMAL** (default)

The waveform recorded in disc will be output with its polarity left intact.

▶ **REVERSE**

The waveform recorded in disc will be output with its reversed polarity.

This preference configures the setting to switch the phase of the analog audio output.

You may give it a try to switch and listen so that an optimum sound quality can be obtained from the amplifier and the speakers on line.

DISPLAY

■ DISC

▶ **DISPLAY** (default)

▶ **NOT**

This preference determines whether or not the disc name is displayed when an MP3/WMA CD is read.

■ FILE

▶ **SCROLL** (default)

▶ **NOT**

This preference determines whether or not the file name scrolls across the display when an MP3/WMA file is selected.

In Navigation mode, the file name scrolls across the display regardless of this setting (→ **23**).

■ FOLDER

▶ **SCROLL** (default)

▶ **NOT**

This preference determines whether or not the folder name scrolls across the display when an MP3/WMA folder is selected.

In Navigation mode, the folder name scrolls across the display regardless of this setting (→ **23**).

■ HIDE-NUM

▶ **DISABLE** (default)

Displays numbers.

▶ **ENABLE**

Hides numbers.

This preference determines whether or not the numbers at the beginning of file and folder names are hidden.

When you create an MP3/WMA CD on a personal computer, you cannot normally determine the playback order of the files. However, if you number the MP3/WMA files in order, starting with 01, 02, 03, and so on, they will play in that order.

■ BAD-NAME

▶ **NOT** (default)

▶ **REPLACE**

This preference determines whether or not file and folder names that contain undisplayable characters are replaced with "FILE n." or "FOLDER n.", "n" being the file or folder number. When set to "NOT", displayable characters are displayed and underscores are used in place of any undisplayable characters. For ID3 tags, underscores are used in place of undisplayable characters regardless of this preference.

EXTRA

■ ID3-VER1

- ▶ **READ** (default)
- ▶ **NO READ**

This preference determines whether or not version 1.0/1.1 tags are read and displayed. When set to “**NO READ**”, version 1.0/1.1 ID3 tags will not be displayed.

■ ID3-VER2

- ▶ **READ** (default)
- ▶ **NO READ**

This preference determines whether or not version 2.2/2.3/2.4 tags are read and displayed. When set to “**NO READ**”, version 2.2/2.3/2.4 ID3 tags will not be displayed.

■ CD-EXTRA

- ▶ **AUDIO** (default)
- ▶ **MP3**

This preference applies to CD Extra discs and determines whether music in the audio session or MP3/WMA files in the data session are played.

■ JOLIET

- ▶ **USE SVD** (default)
- ▶ **ISO9660**

This preference applies to MP3/WMA CDs in Joliet format and determines whether the compact disc player reads the SVD data or treats the disc as an ISO 9660 disc. Normally, this preference doesn't need to be changed. SVD (Supplementary Volume Descriptor) supports long file and folder names and characters other than letters and numbers.

■ STOP-KEY

- ▶ **NAVI** (default)
- ▶ **FOLDER**
- ▶ **DISABLE**

This preference determines how ■ on the compact disc player works.

When the “**NAVI**” (Navigation) option is selected, pressing ■ once selects Navigation mode.

When the “**FOLDER**” (ALL Folder) option is selected, pressing ■ once selects All Folder mode.

When the “**DISABLE**” option is selected, compact disc player does not enter Navigation or All Folder mode by pressing ■.

📄 Note

- This setting has no effect on the remote controller.

ASb (Auto Standby)

■ ASb (Auto Standby)

- ▶ **ON**
- ▶ **OFF**

For compact disc player playback, it is activated when the playback is stopped for 30 minutes; however, it is not activated when the playback is paused continuously.

Default setting: **ON** (European models), **OFF** (North American models)

📄 Note

- Before entering standby mode with the ASb function, the Display Off LED flashes 30 seconds before the ASb function starts running.

INITIAL

■ INITIAL

- ▶ **CANCEL**
- ▶ **EXECUTE**

This preference resets the compact disc player to factory default.

Setting the Analog/Digital Output

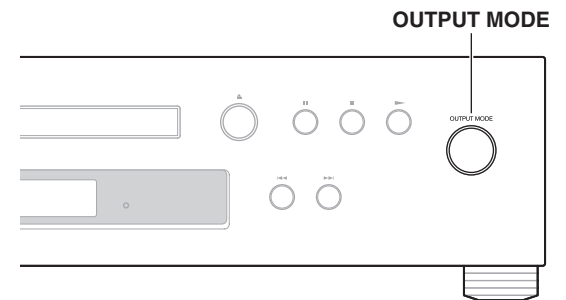

Switch the output between DIGITAL/ANALOG, DIGITAL, ANALOG in order.

1 Press **OUTPUT MODE** repeatedly on the front panel.

The selected Audio output indicator lights.

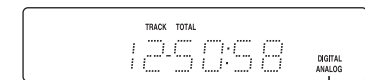

Audio output indicator

▶ **DIGITAL/ANALOG** (default):

Uses both outputs.

▶ **DIGITAL:**

Uses the digital output only.

Turn the analog output off to perform more stable playback.

▶ **ANALOG:**

Uses the analog output only.

Turn the digital output off to reduce the effect of digital noise during playback.

Troubleshooting

Power

Can't turn on the Compact Disc Player.

- Make sure that the power cord is properly plugged into the wall outlet (→ 18).
- Unplug the power cord from the wall outlet, wait 5 seconds or more, then plug it in again.

The Compact Disc Player turns off unexpectedly.

- When the set ASb starts running, the compact disc player will automatically go Standby (→ 32).

Audio

There's no sound.

- Check all connections and correct as necessary (→ 17).
- Make sure that there is no unsupported file formats or signals.
- The compact disc player is equipped with a feature to switch the digital/analog output. Check if the connection between the compact disc player and a connected component is appropriate, and also whether the selection of the selector is correct.

The sound quality is not good.

- Make sure all audio connecting plugs are pushed in all the way (→ 17).
- The sound quality can be affected by strong magnetic fields, such as that from a TV. Try moving any such devices away from the compact disc player.
- If you have any devices that emit high-intensity radio waves near the compact disc player, such as a cellular phone that's being used to make a call, the compact disc player may output noise.
- The compact disc player's precision drive mechanism may emit a faint hissing sound while reading discs during playback or when searching for tracks. You may be able to hear this noise in extremely quiet environments.

Audio output is intermittent when the Compact Disc Player is subjected to vibration.

- The compact disc player is not a portable device. Use it in a location that's not subject to shock or vibration.

Audio performance

- Audio performance will be at its best about 10 to 30 minutes after the compact disc player has been turned on and had time to warm up.
- Using cable ties to bundle audio cables with speaker or power cables may degrade the sound quality. So don't do it.

Disc Playback

Can't play a disc.

- The disc is upside down. Load the disc with the label-side facing up (→ 15, 22).
- The disc is dirty. Remove the disc and clean it (→ 15).
- If condensation appears, unplug the power cord and leave the compact disc player more than 3 hours at room temperature.
- Make sure the disc is standard. See "Disc Note" (→ 15).
- CD-R/CD-RW that are not finalized cannot be played.

Disc playback skips.

- Install the compact disc player somewhere free of vibration.
- The disc is dirty. Remove the disc and clean it (→ 15).
- The disc is very scratched. Replace the disc.

Can't enter track numbers for memory playback.

- No such track on the disc. Enter another number (→ 24).

It takes a long time to locate certain tracks.

- The disc is dirty. Remove the disc and clean it (→ 15).
- The disc is very scratched. Replace the disc.

Can not play tracks in the disc's playback order.

- Turn off any special playback modes (e.g. repeat, memory, or random).

External Components

No sound is heard from a connected component.

- Make sure the audio cable is connected correctly (→ 17).
- Make sure that all audio connecting plugs are pushed in all the way (→ 17).
- Make sure that the connected component's input jack and the input settings are correct.
- Make sure that the connected component's volume isn't set to the lowest level, and that the volume isn't muted.

Remote Controller

The remote controller doesn't work properly.

- Make sure the batteries have been installed with the correct polarity (+/-) (→ 10).
- Replace both batteries with new ones. (Do not mix different types of batteries or new and old batteries.)
- The remote controller is too far away from the compact disc player, or there's an obstacle between them (→ 10).
- The compact disc player's remote control sensor is being subjected to bright light (inverter-type fluorescent light or sunlight).
- The compact disc player is located behind the glass doors of a audio rack or cabinet.

Onkyo is not responsible for damages (such as CD rental fees) due to unsuccessful recordings caused by the unit's malfunction. Before you record important data, make sure that the material will be recorded correctly.

The compact disc player contains a microcomputer for signal processing and control functions. In very rare situations, severe interference, noise from an external source, or static electricity may cause it to lockup. In the unlikely event that this should happen, unplug the power cord, wait at least 5 seconds, and then plug it again.

Before disconnecting the power cord from the wall outlet, set the main power switch to OFF.

Specifications

C-7000R

Frequency Response	2 Hz - 20 kHz
Signal to Noise Ratio	116 dB
Audio Dynamic Range	100 dB
THD (Total Harmonic Distortion)	0.0015 %
Audio Output/Impedance	
Optical	-22.5 dBm
Coaxial	0.5 Vp-p / 75 Ω
AES/EBU	3.3 Vp-p / 110 Ω
Rated RCA Output Level and Impedance	2.0 V (rms) / 330 Ω
Digital Outputs	Optical: 1 Coaxial: 1
Analog Stereo Outputs	L, R
Balance Output	AES/EBU (DIGITAL)
Power Supply	(North American) AC 120 V, 60 Hz (European) AC 230 V, 50 Hz
Power Consumption	(North American) 21 W (European) 18 W
Standby Power Consumption	(North American) 0.2 W (European) 0.3 W
Dimensions (W × H × D)	435 W × 99 H × 315.2 D mm (17-1/8 W × 3-7/8 H × 12-7/16 D inches)
Weight	12 kg (26.5 lbs)
Operation Condition Temperature/Humidity	5 °C - 35 °C/15% - 85%
Playable Discs	Audio CD, CD-R, CD-RW, MP3, WMA (CD-R, CD-RW) * Discs that have not been properly finalized may only be partially playable or not playable at all.

Specifications and features are subject to change without notice.

ONKYO CORPORATION

2-1, Nisshin-cho, Neyagawa-shi, OSAKA 572-8540, JAPAN
Tel: 072-831-8023 Fax: 072-831-8163

ONKYO U.S.A. CORPORATION

18 Park Way, Upper Saddle River, N.J. 07458, U.S.A.
Tel: 800-229-1687, 201-785-2600 Fax: 201-785-2650 <http://www.us.onkyo.com/>

ONKYO EUROPE ELECTRONICS GmbH

Liegnitzerstrasse 6, 82194 Groebenzell, GERMANY
Tel: +49-8142-4401-0 Fax: +49-8142-4401-555 <http://www.eu.onkyo.com/>

ONKYO EUROPE ELECTRONICS GmbH (UK BRANCH)

The Coach House 81A High Street, Marlow, Buckinghamshire, SL7 1AB, UK
Tel: +44-(0)1628-473-350 Fax: +44-(0)1628-401-700

ONKYO CHINA LIMITED

Unit 1 & 12, 9/F, Ever Gain Plaza Tower 1, 88, Container Port Road, Kwai Chung, N.T., Hong Kong.
Tel: 852-2429-3118 Fax: 852-2428-9039
<http://www.ch.onkyo.com/>

SN 29400529

(C) Copyright 2010 ONKYO CORPORATION Japan. All rights reserved.

Y1011-1



* 2 9 4 0 0 5 2 9 *